

### Series 400 Soft Seal Shelter

**Chalfant Series 400 Soft Seal Shelter** provides a effective seal between your building and truck at your loading dock. Designed with the common variety of trucks in mind.

#### Standard Construction Features Summary

- The Series 400 Soft Seal Shelter provides tight seal against truck and prevent weather, dust, bugs, exhaust fumes from entering building.
- High resilient premium grade polyurthane foam, bonded with high quality liquid adhesive to kiln dried wood, all are encased inside the dock seal fabric cover to protect it from abuse and the elements (optional 14 gauge galvanized steel backing also available).
- All pads are equipped with air vents to help minimize rupture, and drain holes equipped with brass grommet type drain holes to reduce moisture build-up.
- Raked head frame with curtain that services a wide variety of trucks with a standard curtain height of 36".
- Wide variety of tested high quality fabrics available.
- One (1) year Guarantee against manufacturing defects in material & workmanship from date of installation. \*(see warranty)

#### 3-in-1 Guardian Dor-Seal System Options

- Foam backing - Conforms to building wall irregularities.
- Extra wood substructure - Strong, secure connections for installations.

#### General Options

- Flame-retardent fabric
- Door numbers on unit (specify in notes)
- Reinforce inside side pad wear face;  48" high  96" high
- Bottom draft flaps:  3"  6"  Inside  Front  All
- Metal hood length:  10'  12'; Proj.:  14"  18"  24"  36"
- Full "Z" pattern top of side curtain  3-Ply-reinforcement bottom



Shown with optional full length guide stripe and door number

The Series 400 Soft Seal Shelter features a unique design that acts like a shelter and dock seal combined. The Series 400 Soft Seal Shelter provides foam side pads and dock shelter style curtain, that allows full access to the rear of the trailer and yields under off-center trucks impact, due to improper positioning at the loading dock.



**Chalfant has pioneered**, developed and provided the industry with quality loading dock equipment since 1940. Safe, affordable, reliable dock equipment, to meet your application needs.

#### Select Base Fabric And Unit Color

- |                                      |                                      |  |  |   |   |  |
|--------------------------------------|--------------------------------------|--|--|---|---|--|
| <input type="checkbox"/> 22 oz Vinyl | <input type="checkbox"/> 40 oz Vinyl | <input type="checkbox"/> 16 oz Hypalon | <input type="checkbox"/> 40 oz Hypalon | <input type="checkbox"/> 16 oz Neoprene | <input type="checkbox"/> 40 oz Neoprene | <input type="checkbox"/> High-Tear Resistant Guardian 60 |
| <input type="checkbox"/> Black       | <input type="checkbox"/> Black       | <input type="checkbox"/> Black         | <input type="checkbox"/> Black         | <input type="checkbox"/> Black          | <input type="checkbox"/> Black          | <input type="checkbox"/> Black                           |
| <input type="checkbox"/> Blue        | <input type="checkbox"/> Blue        | <input type="checkbox"/> Blue          | <input type="checkbox"/> Blue          | <input type="checkbox"/> Tan            | <input type="checkbox"/> Tan            |  |
| <input type="checkbox"/> Tan         | <input type="checkbox"/> Tan         | <input type="checkbox"/> Green         | <input type="checkbox"/> Brown         |   |   |  |
| <input type="checkbox"/> Green       | <input type="checkbox"/> Brown       | <input type="checkbox"/> Brown         |  |   |   |  |
| <input type="checkbox"/> Brown       |                                      |  |  |   |   |  |

Note: Samples of materials are available upon request, consult Chalfant for other available colors.

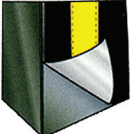
#### Select Optional Contact Face

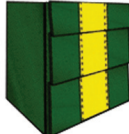
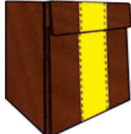
- |   |   |   |  |   |
|---|---|---|--|---|
| <input type="checkbox"/> Wear Face  | <input type="checkbox"/> Guardian Face  | <input type="checkbox"/> Guardian Pleat GP4   | <input type="checkbox"/> Guardian Pleat GP8  | <input type="checkbox"/> Guardian Pleat GP 16   |
|  |  |  |  |  |
|   |   | For Heavy Use.<br>Exposure: 4"<br>Overlap: 5"<br>Total Length: 9"                   | For Medium Use.<br>Exposure: 8"<br>Overlap: 10"<br>Total Length: 18"                 | For Medium Use.<br>Exposure: 16.5"<br>Overlap: 1.5"<br>Total Length: 18"              |

#### Select Contact Fabric

- 22 oz Vinyl
- 40 oz Vinyl
- 16 oz Hypalon
- 40 oz Hypalon
- 16 oz Neoprene
- 40 oz Neoprene
- High-Tear Resistant Guardian 60

Consistent with our policy of continuing product improvement, we reserve the right to change these specifications without notice or obligation.

### Series 400 Soft Seal Shelter

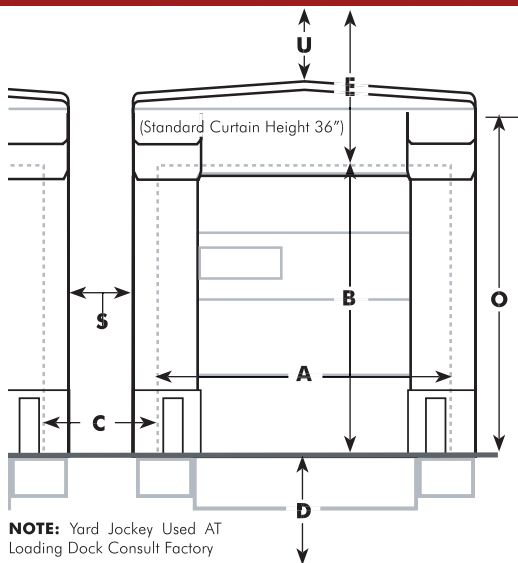

**NOTE:** Yard Jockey Used AT Loading Dock Consult Factory

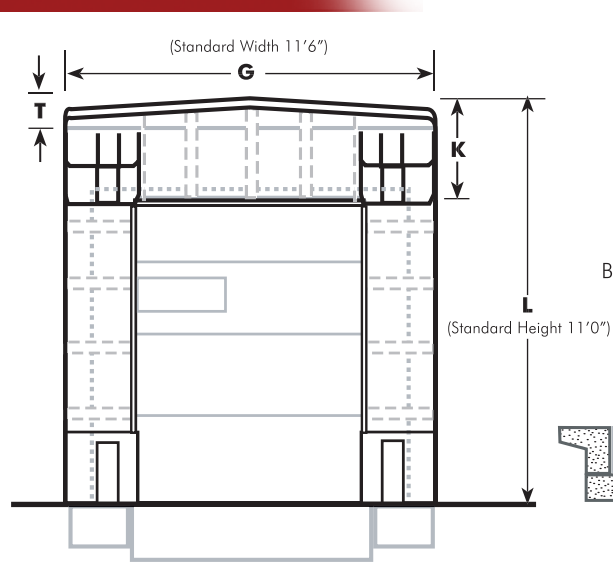

**NOTE:** Building Projection Past Dock Face Wall - Consult Factory

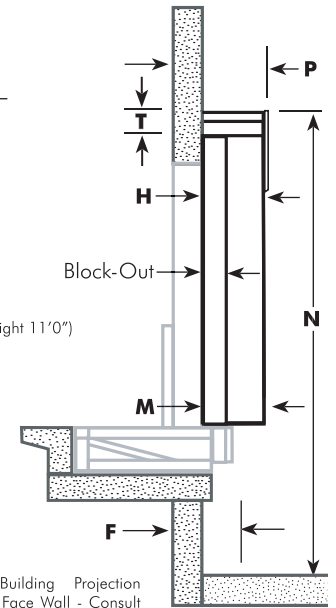

#### General Information

Model \_\_\_\_\_ Color \_\_\_\_\_  
 Door Size: Width-**A** \_\_\_\_\_ Height-**B** \_\_\_\_\_  
 Number Of Units \_\_\_\_\_ Base Fabric \_\_\_\_\_  
 Contact Material \_\_\_\_\_ Contact Face Type \_\_\_\_\_  
 Inside Wear Face \_\_\_\_\_  Flame-Retardent Fabric  
 Full "Z" Pattern Top Of Side Curtain  3-Ply Reinforcement Bottom  
 Guide Stripe:  Yellow  Orange  Full Length  Standard Length  
 Dock Height-**D** \_\_\_\_\_ Dock Bumper Projection \_\_\_\_\_  
 Plus Wall Set Back \_\_\_\_\_ Total-**F** \_\_\_\_\_  
 Approach:  Level Drive Approach  % of Decline \_\_\_\_\_  
 % of Incline \_\_\_\_\_  
 Distance: Between Doors-**C** \_\_\_\_\_  Between Units-**S** \_\_\_\_\_  
 Clearance : Above Doors-**E** \_\_\_\_\_  Above Unit-**U** \_\_\_\_\_

#### Standard Seal Information

Side Member Length-**O** \_\_\_\_\_  Block-Out Projection- \_\_\_\_\_  
 Bottom Projection of Unit-**M** \_\_\_\_\_ Top Projection of Unit-**H** \_\_\_\_\_  
 Head Frame Style-**T** \_\_\_\_\_  Raked  Flat Side Curtain Width \_\_\_\_\_  
 Head Frame Projection-**P** \_\_\_\_\_ Block-Out Projection- \_\_\_\_\_  
 Front of Seal Opening: Width \_\_\_\_\_ Height \_\_\_\_\_  
 Overall Outside Unit Dimensions Width-**G** \_\_\_\_\_ Height-**H** \_\_\_\_\_  
 Total Height of Unit From Driveway-**N** \_\_\_\_\_  
**Head Curtain Height-K** \_\_\_\_\_  
 Velcro  Adjustable Drop Curtain With Pull Ropes  
 Foam Front Specify \_\_\_\_\_  Weighted  Door Numbers \_\_\_\_\_

#### Truck Service Range

Min. Height \_\_\_\_\_ Max. Height \_\_\_\_\_  
 Min. Width \_\_\_\_\_ Max. Width \_\_\_\_\_

**SPECIFY MOUNTING**

Type B: Soft-Shelter, Off-Set Moun

**CURTAIN** - Width of Curtain \_\_\_\_\_

**OPEN DOCK POSITION**  
400 Series Side Pad

**TRUCK IN POSITION**  
400 Series Curtain In Compression

Customer: \_\_\_\_\_  
 Signature Approval By: \_\_\_\_\_  
 Project: \_\_\_\_\_  
 Address: \_\_\_\_\_  
 City: \_\_\_\_\_ State: \_\_\_\_\_  
 Architect/GC: \_\_\_\_\_

Authorized Dealer